

# Low Voltage Fuses (LV Fuses)

LFR2836-xA05-y Series

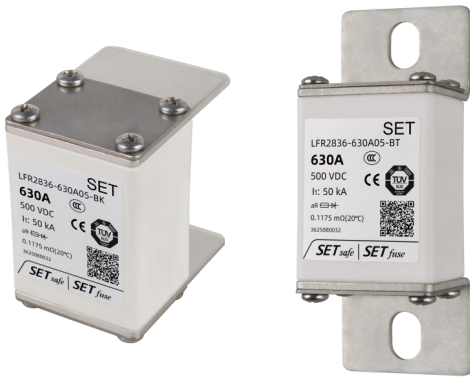

## Key Features

- Rated Voltage: 500 VDC
- Breaking Capacity: 50 kA
- Fusing Characteristics: High Speed Fuse
- Utilization Category: aR
- Good Current Limiting Capability
- Body Size: 57x36.3x28 mm
- RoHS and REACH Compliant, Pb Free

## Applications

- Power conversion devices
- DC systems
- Energy Storage System (ESS)
- DC Charging Pile
- Manual Switch Disconnecter (MSD)

## Dimensions (mm)

Mounting: BT (Bolt Tag)

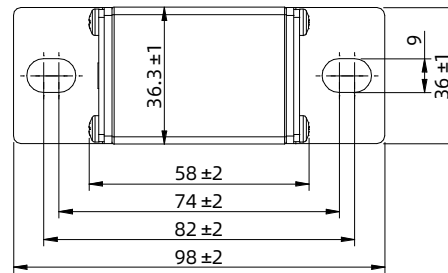
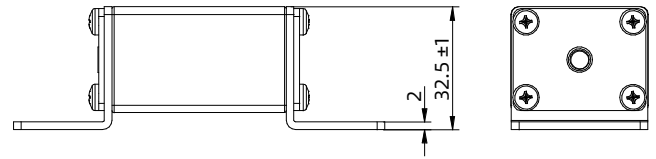

Mounting: BK (Bolt Knife)

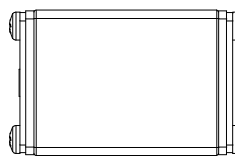
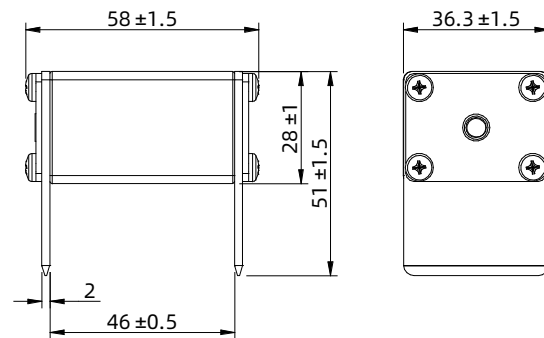

## Agency Information



Rated Current $I_n$ (A)	Agency Symbol	Standards	The File No. and certification No. obtained by SETsafe   SETfuse	Utilization Category
100 ~ 630		GB/T 13539.4	2025010308804261	aR
		EN 60269-4	B 107221 0015	aR
		EN 60269-4	N8A 107221 0016	aR

## Part Numbering System

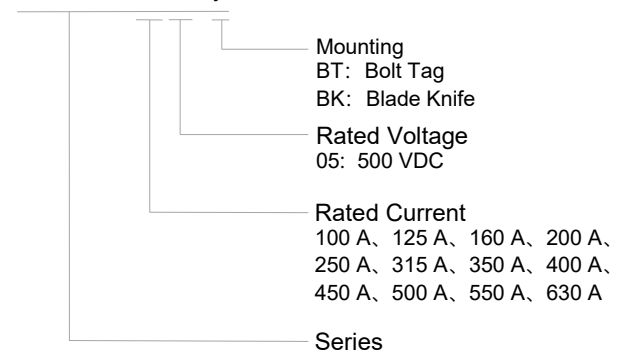
LFR2836 - xA05 - y



### Specifications

Model	Rated Voltage $U_n$	Rated Current $I_n$	Breaking Capacity $I_1$				RoHS REACH Pb-free
	(VDC)	(A)	(kA)	CCC	TUV	CE	
LFR2836-100A05-BT/BK	500	100	50	●	●	●	●
LFR2836-125A05-BT/BK	500	125	50	●	●	●	●
LFR2836-160A05-BT/BK	500	160	50	●	●	●	●
LFR2836-200A05-BT/BK	500	200	50	●	●	●	●
LFR2836-250A05-BT/BK	500	250	50	●	●	●	●
LFR2836-315A05-BT/BK	500	315	50	●	●	●	●
LFR2836-350A05-BT/BK	500	350	50	●	●	●	●
LFR2836-400A05-BT/BK	500	400	50	●	●	●	●
LFR2836-450A05-BT/BK	500	450	50	●	●	●	●
LFR2836-500A05-BT/BK	500	500	50	●	●	●	●
LFR2836-550A05-BT/BK	500	550	50	●	●	●	●
LFR2836-630A05-BT/BK	500	630	50	●	●	●	●

Note: 1. "●": Certification Obtained, RoHS and REACH Compliant, Pb Free.

2. BT Mounting: M8 Bolts and Nuts are Recommended, Recommended Installation Torque 12 N·m.

3. The minimum breaking capacity:  $6 I_n$

### Time-Current Characteristics (For Reference Only)

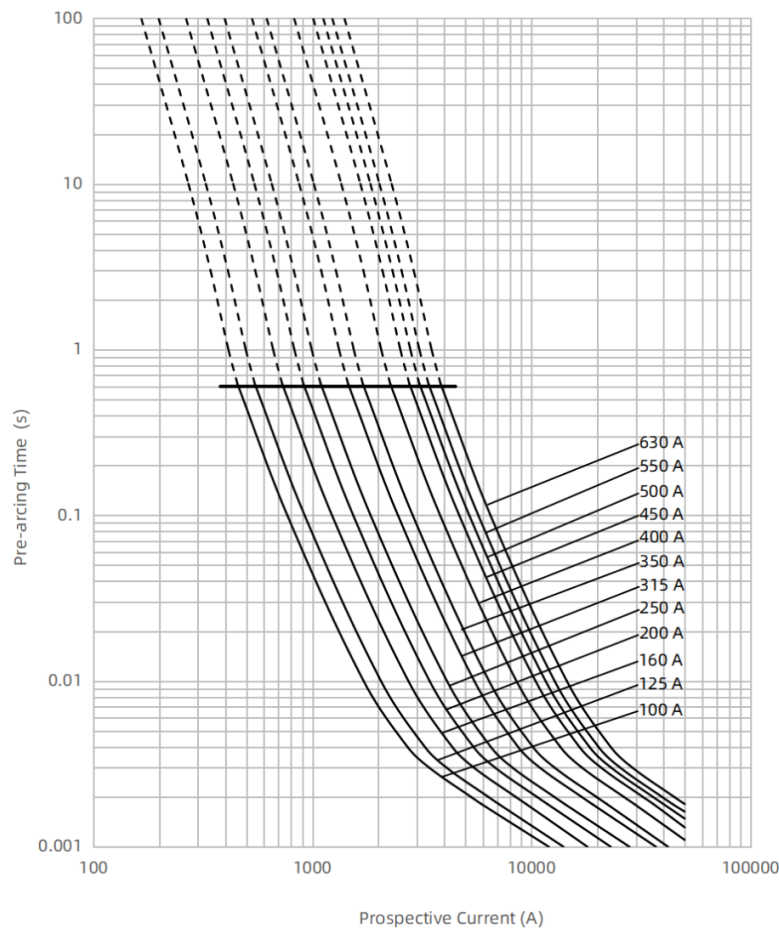

## Truncated Current Curve (For Reference Only)

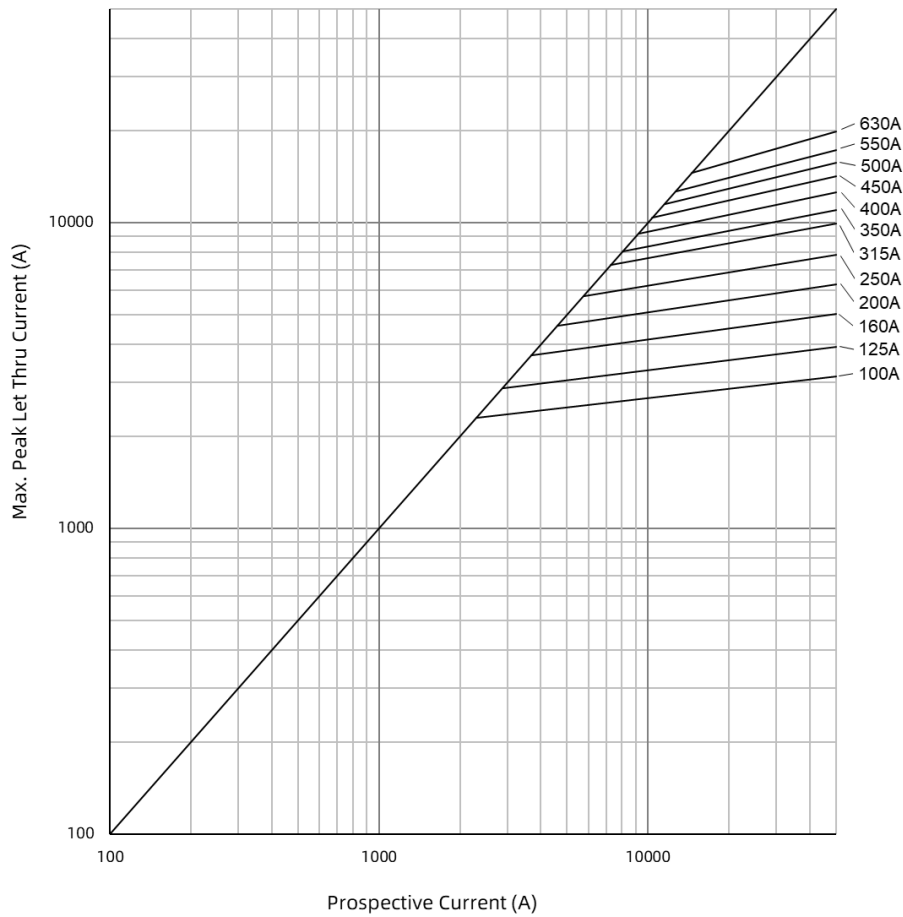

## Packaging

Item	Pearl Cotton Pallet		Carton
Product Quantity (PCS)	15		60
Product Weight (g)	205x(1±10%)	Gross Weight (kg)	13.3x(1±10%)

Packaging Drawing:

Unit: mm

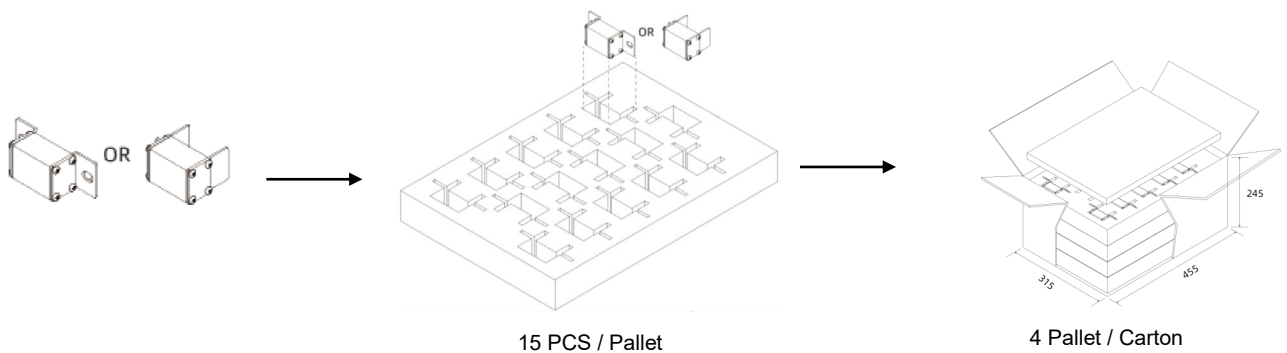

## Power Dissipation Curve (For Reference Only)

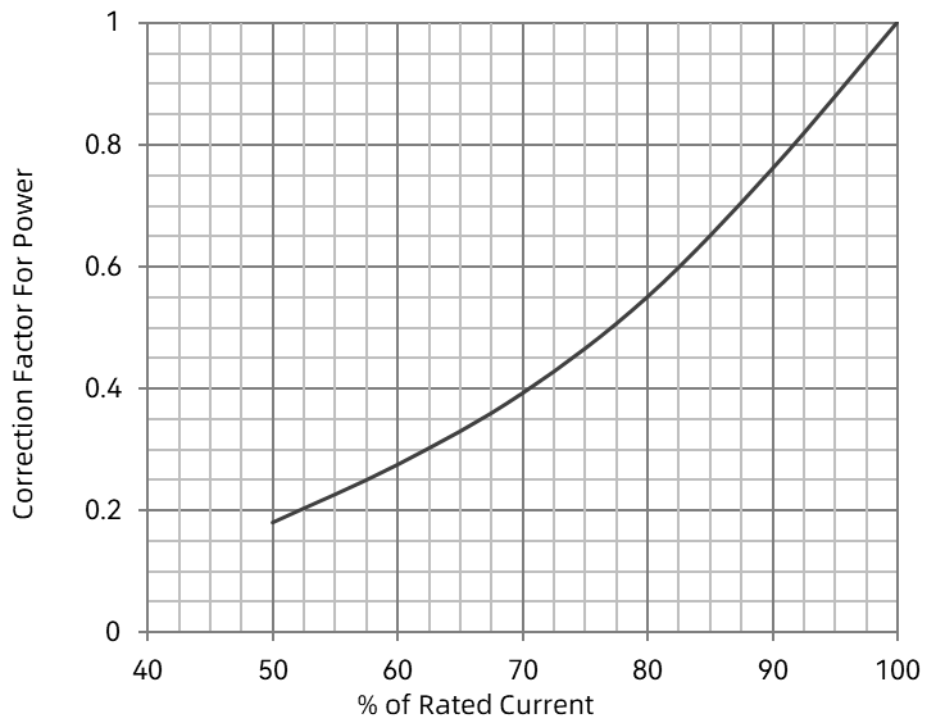

## Rated Current Derating Curve

Ambient Temperature (For Reference Only)

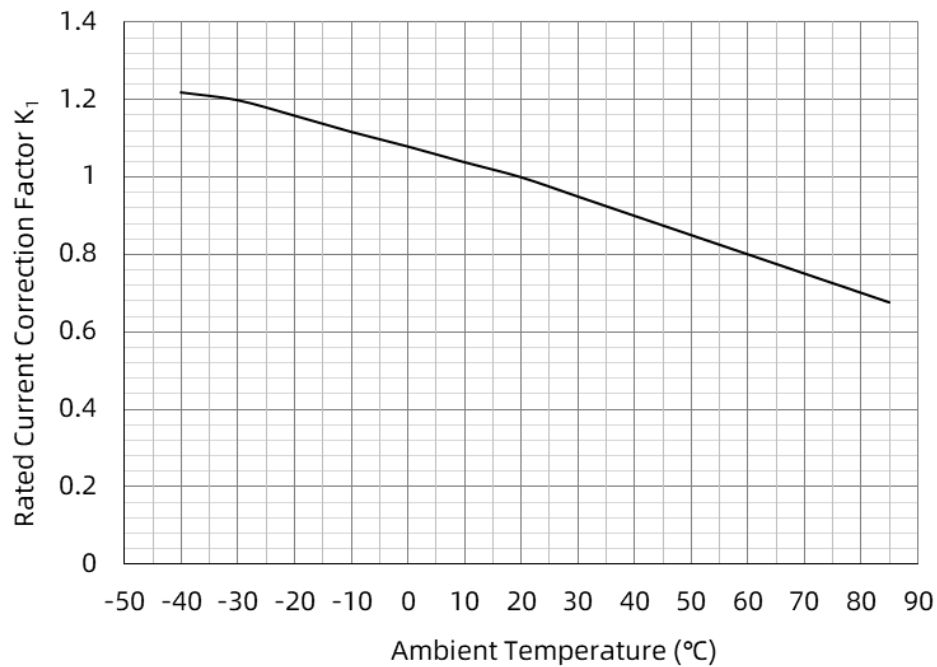

## Connecting Conductor (For Reference Only)

The current density of copper bar for fuse installation is suggested to be 1.3 A/mm<sup>2</sup>. If the carrying current density of copper bar is greater than 1.3 A/mm<sup>2</sup>, it is recommended to reduce the rated current of fuse appropriately.

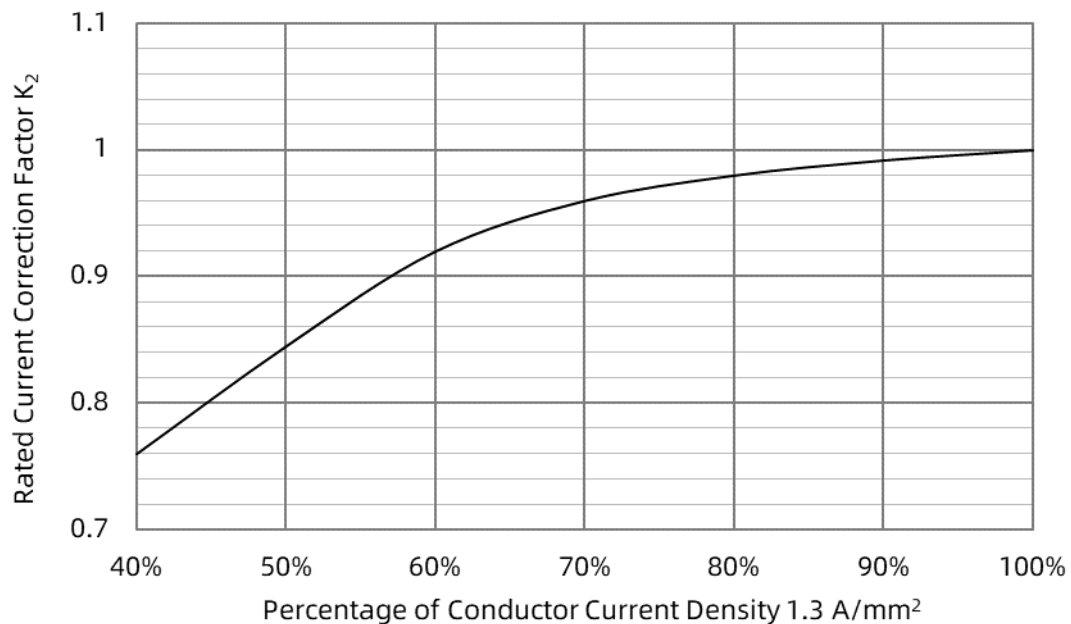

## Cooling Air (For Reference Only)

When the fuse operates in the environment with cooling air, the rated current value of the fuse needs to be corrected.

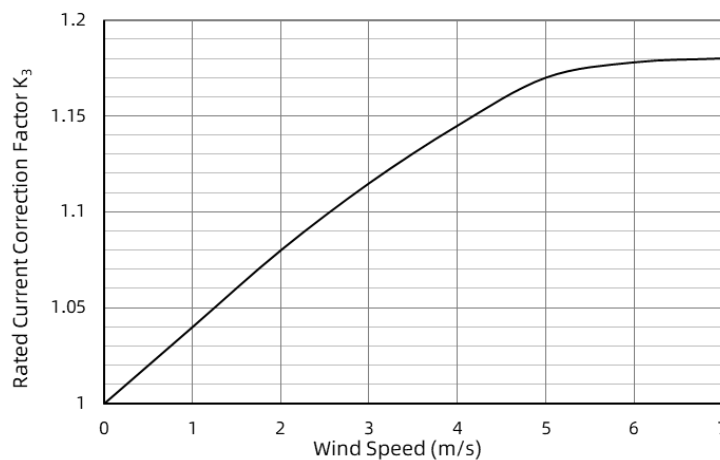

## Altitude (For Reference Only)

Altitude (m)	Derating Factor $K_4$
2000	1.000
2500	0.975
3000	0.950
3500	0.925
4000	0.900
4500	0.875
5000	0.850

## Rated Current:

$$I_n \geq \frac{K_0 I_c}{K_1 K_2 K_3 K_4 K_5}$$

$I_c$  — Long-term continuous operating current

$K_1$  — Ambient temperature correction factor

$K_3$  — Cooling air correction factor

$K_5$  — Closed environment correction factor, for the better heat dissipation conditions of the box to take 0.9 ~ 0.95, while for the poorer take 0.8

$K_0$  — Reliability factor: 1.2 (Reference DL/T 5044-2014)

$K_2$  — Correction factor for connecting conductors

$K_4$  — Altitude correction factor



# ATTENTION

## Replacement

The fuse is a non-resettable product, for safety reasons, please ensure that the spare fuse is same model.

## Installation Position

Do not install the fuse on an assembly that may often subject to severe continuous vibration or with corrosive gases ( $\text{NH}_3$ ,  $\text{SO}_2$ ,  $\text{Cl}_2$  etc.).

## Transportation

During packaging and transportation, rain and snow and mechanical damage shall be avoided.

## Storage Conditions and Effective Date

- Storage temperature:  $10^\circ\text{C}\sim 30^\circ\text{C}$ .
- Storage humidity: 30%~70%.
- Sealed in a place with no sunshine no pollution and without corrosive gases( $\text{NH}_3$ , $\text{SO}_2$ , $\text{Cl}_2$ , etc.).
- Validity period: 12 consecutive months after you receive it.

## Glossary

Item	Description
<b>Fuse</b>	Device that by the fusing of one or more of its specially designed and proportioned components opens the circuit in which it is inserted by breaking the current when this exceeds a given value for a sufficient time. —(IEC 60269-1)
<b>Rated Current of a fuse-link</b> $I_n$	Value of current that fuse-link can carry continuously without deterioration under specified conditions. —(IEC 60269-1)
<b>Prospective Current (of a circuit and with respect to a fuse)</b>	Current that would flow in the circuit if each pole of the fuse were replaced by conductor of negligible impedance. —(IEC 60269-1)
<b>Rated Voltage</b> $U_n$	A maximum open circuit voltage in which a fuse can be used, yet safely interrupt an overcurrent. Exceeding the voltage rating of a fuse impairs its ability to clear an overload or short circuit safely. —(IEC 60269-1)
<b>Ampere Squared Seconds</b> $I^2t$	The melting, arcing, or clearing integral of a fuse, termed $I^2t$ , is the thermal energy required to melt, arc, or clear a specific current. It can be expressed as melting $I^2t$ , arcing $I^2t$ or the sum of them, clearing $I^2t$ . —(IEC 60269-1)
<b>Time-current Characteristics</b>	Current giving the time, e.g. pre-arcing time or operating time as a function of the prospective current under stated conditions of operation. —(IEC 60269-1)
<b>Breaking Capacity</b>	Value of prospective current that a fuse is capable of breaking at a stated voltage under prescribed conditions of use and behavior. —(IEC 60269-1)
<b>Breaking Range</b>	Breaking range is a range of prospective currents within which the breaking capacity of a fuse-link is assured. —(IEC 60269-1)
<b>Pre-arcing Time / Melting Time</b>	Interval of time between the beginning of a current large enough to cause a break in the fuse-element(s) and the instant when an arc is initiated. —(IEC 60269-1)
<b>Arcing Time</b>	Interval of time between the instant of the initiation of the arc in a fuse and the instant of final arc extinction in that fuse. —(IEC 60269-1)
<b>Operating Time / Total Clearing Time</b>	Sum of the pre-arcing time and the acting time. —(IEC 60269-1)
<b>Power Dissipation (in a fuse-link)</b>	Power released in a fuse-link carrying a stated value of electric current under prescribed conditions of use and behavior. —(IEC 60269-1)
<b>Correction Factor of Rated Current</b>	When the application environment and working conditions exceed in the conditions specified in the standard, for the purpose of matching the working current and long service life of the fuse, the rating of fuse should be corrected by a correction factor. Consult the fuse manufacturer for specific application recommendations. —(IEC 60269-1)
<b>Cut-off Current</b>	Maximum instantaneous value reached by the current during the breaking operation of a fuse-link when it operates in such a manner as to prevent the current from reaching the otherwise attainable maximum. —(IEC 60269-1)
<b>Cut-off Current Characteristic/ Let-through Current Characteristic</b>	Curve giving the cut-off current as a function of the prospective current under stated conditions of operation. —(IEC 60269-1)